

RAM

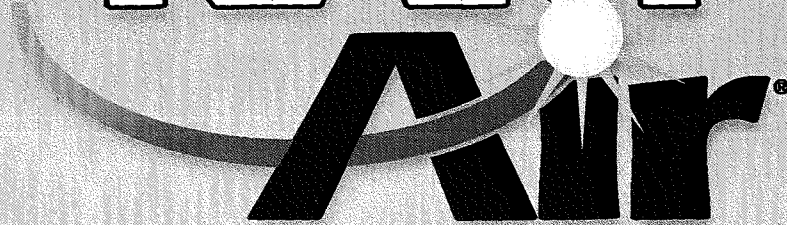

ClearView Duct Cleaning System

User's Manual

Congratulations!

We feel that the RamAir ClearView Duct Cleaning System is the most effective duct cleaning system available. It's also one of the easiest to use. This User's Manual will cover the three simple steps necessary to effectively clean the ducts, furnace and filtration systems found in nearly all types of buildings.

Training and Marketing Module

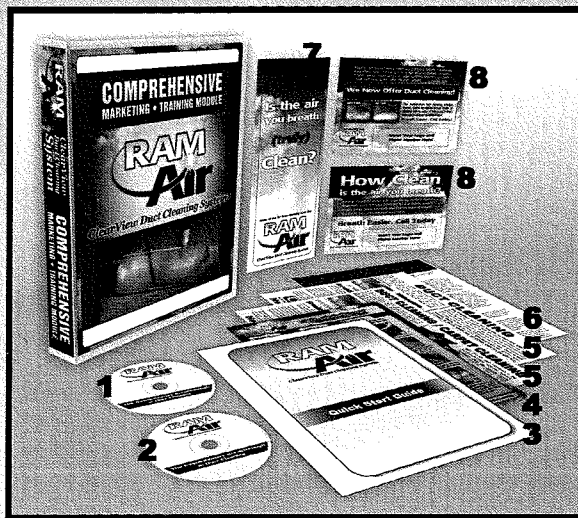

1. Electronic Toolkit Computer CD-ROM
2. Training and Marketing DVD
3. User's Manual
4. Quick Start Guide
5. Sample Flyers
6. Open Box License Agreement
7. Sample Brochure
8. Sample Postcards

About The Module

This training module is designed to help you make your new duct cleaning business a success as quickly as possible. The module is comprised of two parts: **Training and Marketing.**

The training portion of the module is comprised of the User's Manual that you are now reading, the training video which is found on the DVD and computer CD ROM, and the QuickStart Guide.

The marketing side of the module includes a marketing video on DVD and on the CD-ROM, a pre-produced 30-second TV commercial on DVD and on the CD-ROM, as well as printed examples of 2 postcards, a tri-fold brochure, 2 window flyers and all source files on the CD-ROM for you to use to create custom-printed materials of your own.



ClearView Duct Cleaning System

Module Component Overview

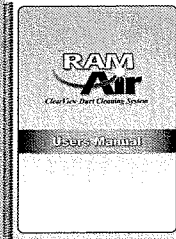

User's Manual

READ THOROUGHLY - To ensure maximum effectiveness of your new RamAir ClearView Duct Cleaning System, please read this User's Manual completely and make sure that you understand every step before putting the RamAir system to work.



Quick Start Guide

USE AS A QUICK REFERENCE IN THE FIELD - Once you have finished reading the manual and are familiar with the process, use the Quick Start Guide as a quick reminder for the first couple of jobs, and as a cue sheet for junior employees.



Training and Marketing DVD

TRAINING VIDEO - Designed to compliment the information in the User's Manual and Quick Start Guide.

MARKETING MESSAGE - Useful for trade shows and while inside the home of existing carpet cleaning customers.

30-SECOND TV AD - Designed to be tagged with your company logo and phone number.



Computer CD-ROM

PDF FILES - To view and plan customizing of your printed materials.

INDESIGN FILES - Files that your commercial printer will use to print custom materials with your specified changes.

BACKGROUND ART - Graphic Components to be used to create custom print materials.

TEXT DOCUMENTS - Marketing messages in text formats.

30-SECOND SPOT - A universal high quality QuickTime file for use by a local broadcast production facility in your area.



Examples of Printed Marketing Materials

PROVIDED AS EXAMPLES - These materials were produced to provide you with tangible examples of the different advertising materials contained on the computer CD-ROM, that have been time-tested to produce amazing results.



ClearView Duct Cleaning System

Kit Hardware

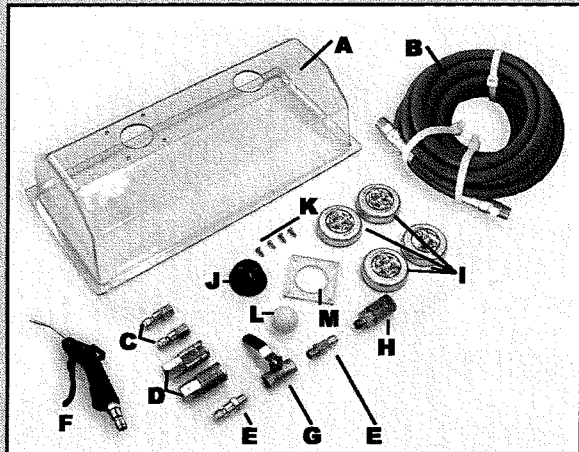

- A. Vacuum Box
- B. Duct Hose
- C. Air Hose Female Fitting (x2)
- D. Quick Connect Female Fitting (x2)
- E. Valve Male End (x2)
- F. Air Gun
- G. Valve
- H. Air Compressor 3/8" Converter
- I. Visual Reference Lights
- J. Grommet
- K. Grommet assembly Screws (x4)
- L. Duct Ball
- M. Grommet Clamp

Additional Items (Not in Kit)

Air Hose: Two 50' (Purchase high grade rubber hose, it is more flexible and durable.)

Air Compressor: Minimum: 6 CFM, 4 Gallon Capacity. We recommend a 9+ CFM gasoline powered "wheelbarrow type."

Extra Long Duct Hose: Can also be purchased for cleaning extra long ducts ie; mobile homes.

Dust Downer: Available at your local cleaning supply distributor.

1½" Diameter Vacuum Hose: 20' length - Available at your local cleaning supply distributor.

Before you begin.

Assemble the vacuum box and valve assembly according to the illustrations below.

Vacuum Box

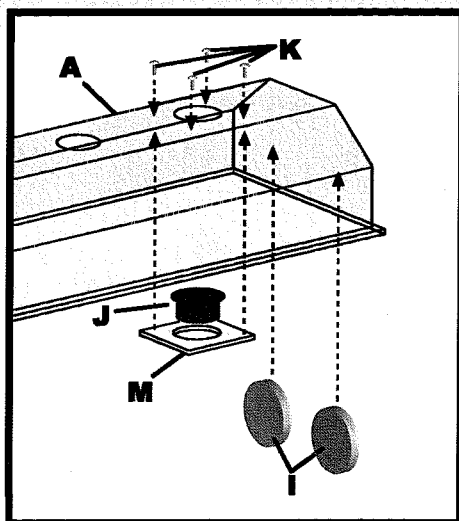

Valve Assembly

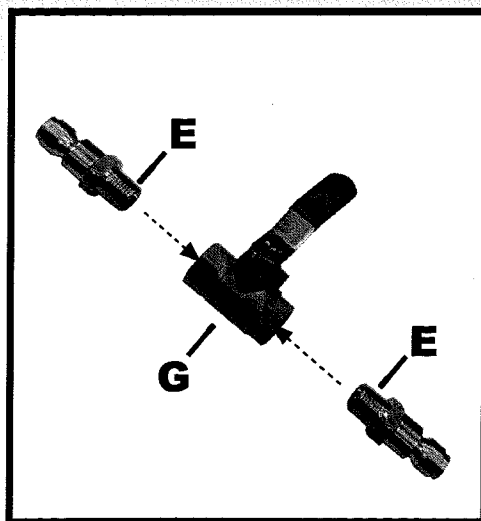

Cleaning the return air ducts and grill.

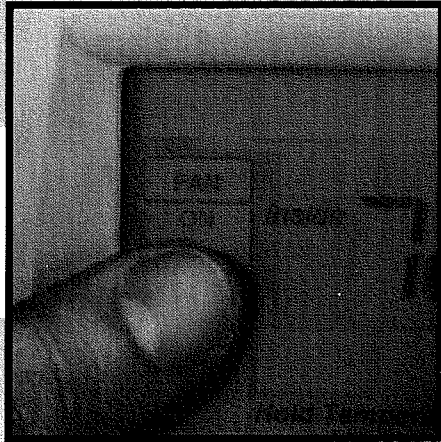

Set the thermostat to "FAN ON". We want the air handler fan running to ensure that air is moving from the return duct, through the filter system and out towards the supply ducts.

Remove the air return grill and take it outside to clean it with the gun attachment.

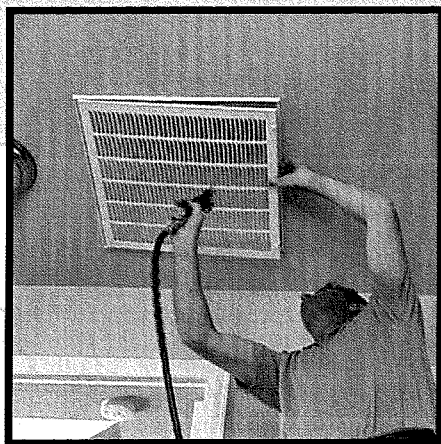
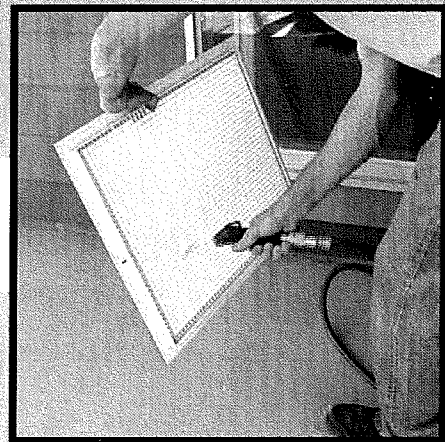

If the grill is not removable, clean it in place making sure that the dust is being blown into the return duct and not into the building.

Now use the gun to clean the entrance of the return air duct. A brush may be helpful to loosen debris stuck in corners and tight spots.

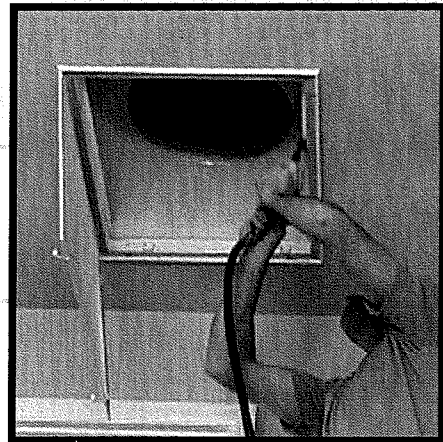

Cleaning the return air ducts and grill.

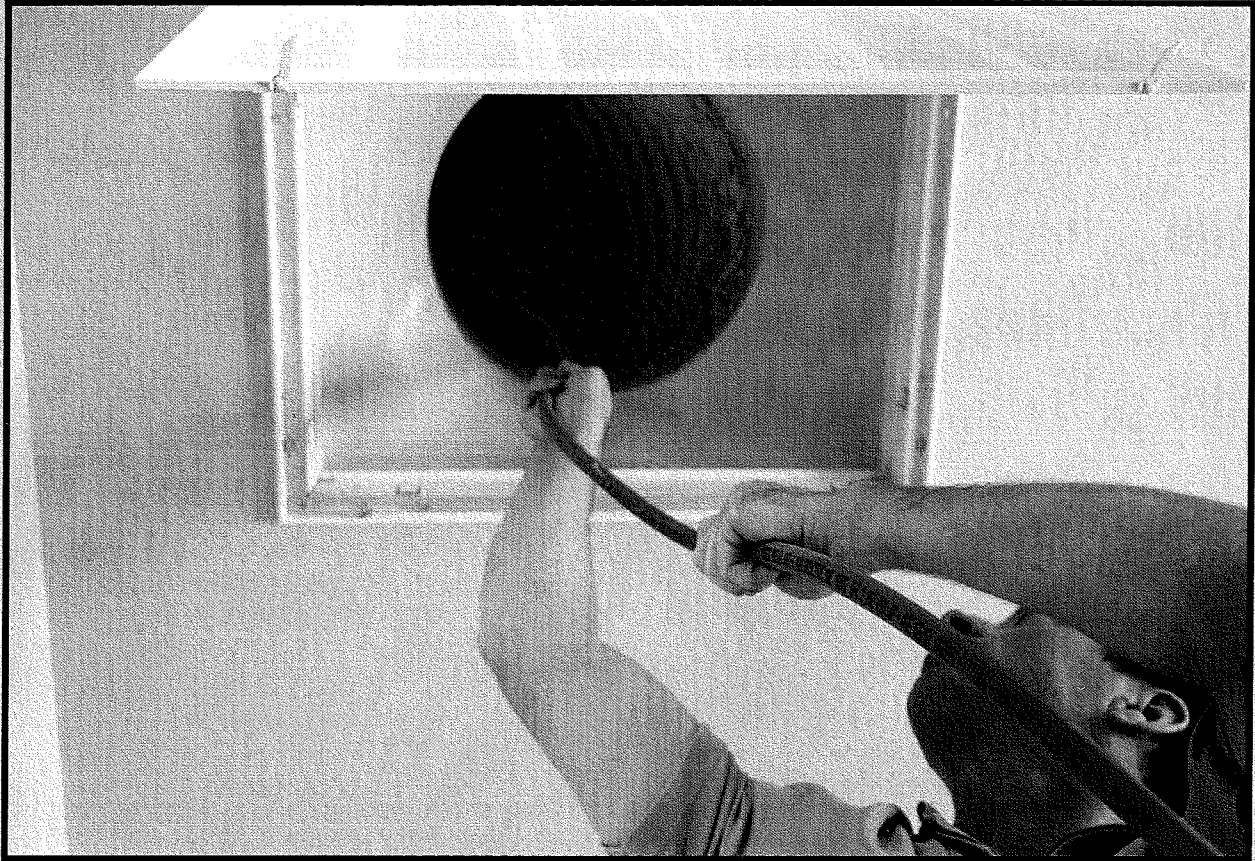

Attach the duct ball to the cleaning hose and insert it into the return duct to start blasting debris back towards the filter. Turn the air valve on and feed the hose into the duct with a twisting motion so that every surface gets blasted with air. As you feed the hose into the duct you'll feel the jet-propelled design of the duct ball pulling the hose deeper into the duct.

Once you're satisfied that the entire return duct has been thoroughly cleaned, replace the air return grill and locate the furnace to begin cleaning the air handler and filter system.

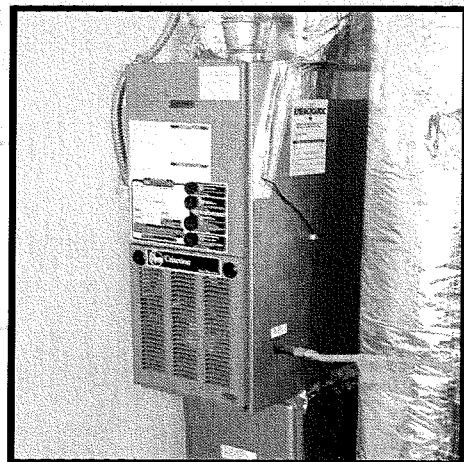

RAM
Air

ClearView Duct Cleaning System

Cleaning the return air ducts and grill.



Remove the filter from the air handler and set it aside for now; this will get cleaned later.

Remove the inspection cover from the furnace exposing the controller board and fan.

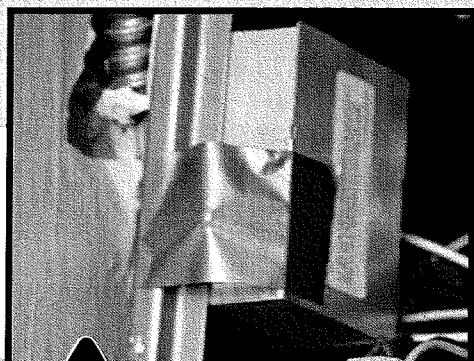
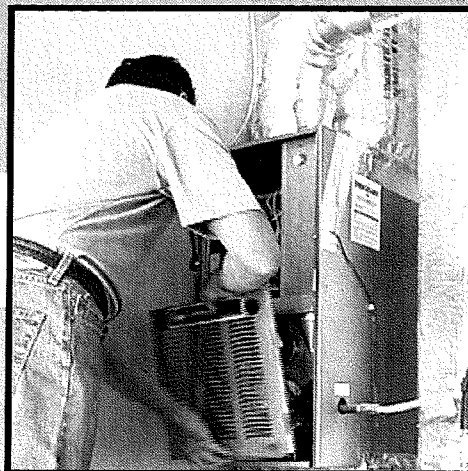

Locate the fan shut off switch and tape the switch down so that the fan will continue to run while you clean. This will ensure that any excess debris will get pulled into supply ducts and not back into your work area.



Use the duct ball and gun attachments to thoroughly clean the plenum.

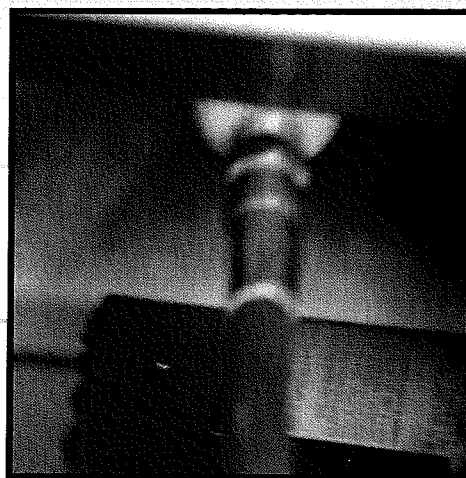

Cleaning the return air ducts and grill.



Use the gun to blow out the fan area and the inside of the furnace. Address all of the panels you can easily reach including the access panel you first removed.

Cleaning the filter system.

Most furnaces use one of 3 kinds of filters: disposable, reusable and electronic.

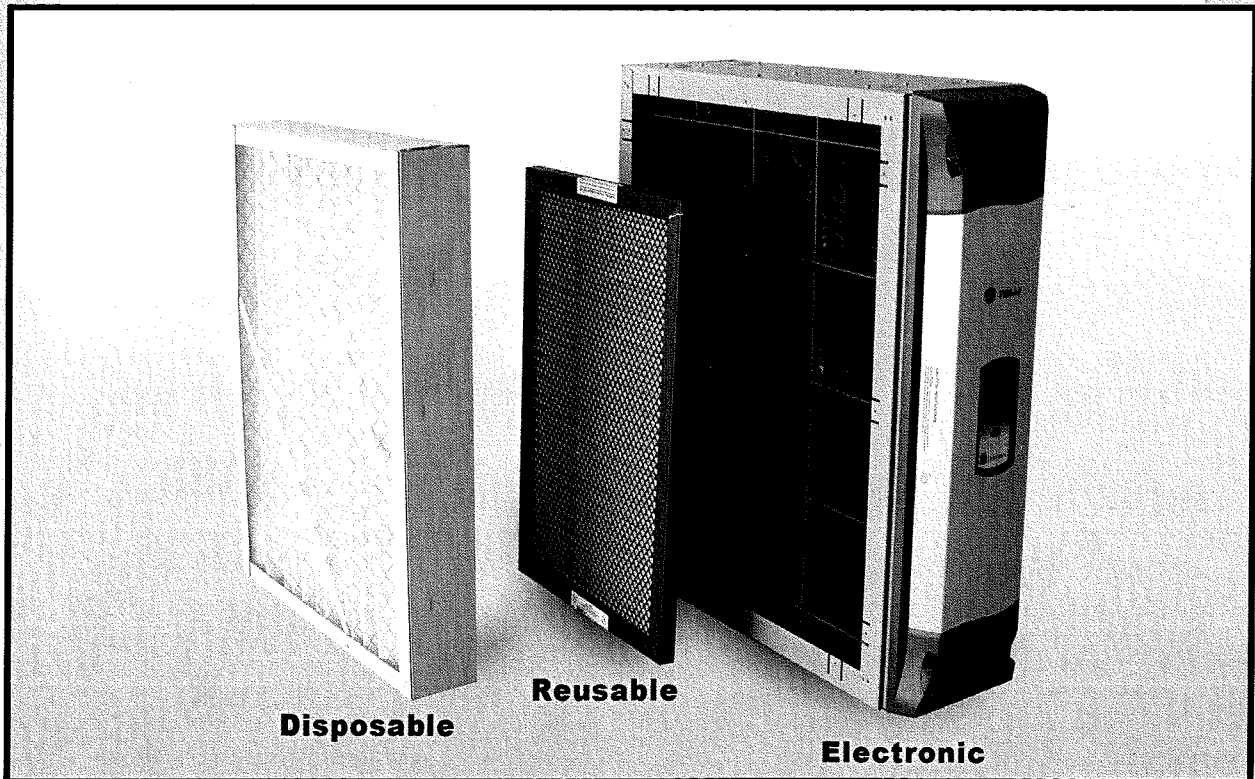

Disposable filters.



For disposable filters, simply remove the filter and replace with a new one.

If no replacement is available, use the gun to blow out any surface debris making sure that you're blowing in the opposite direction of the air direction arrow printed on the filter.

Badly clogged or damaged filters should be replaced.

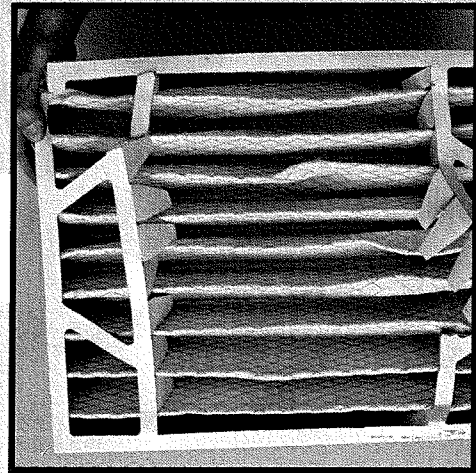

Reusable and electronic filters.

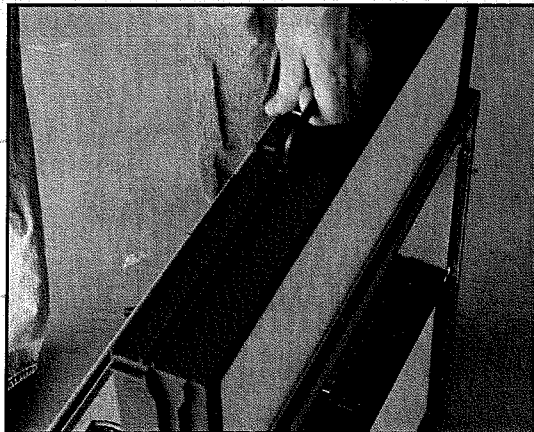

First remove the filter and any pre and post filter screens.

Reusable and electronic filters.

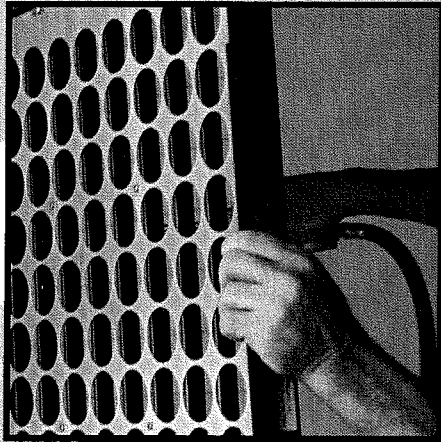

Next, use the gun to aggressively blow any debris from the fan and filter screen surfaces. Be sure to blow the filter blades from all angles.

Replace the filter screens and electronic filter.

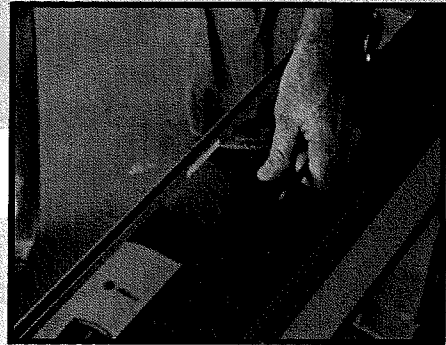

Cleaning the supply ducts.

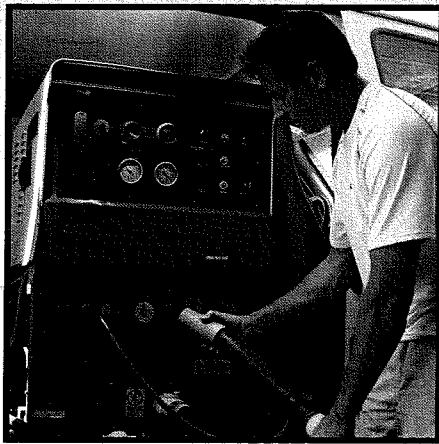

If you are using a truck-mounted vacuum unit, install the "Dust Downer" attachment.

Starting on the highest floor, locate the farthest register cover and remove it.

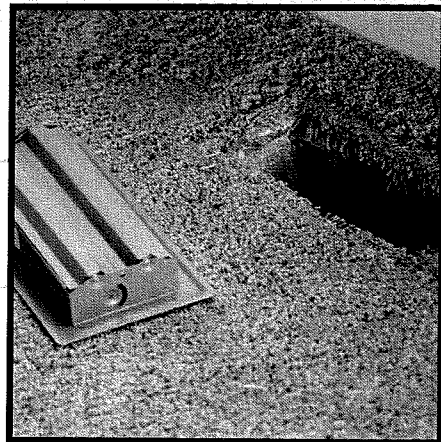

Cleaning the supply ducts.



Feed the duct ball and cleaning hose into the duct gently twisting and turning the hose to help it go around turns or corners. Feed the cleaning hose into the duct as far as it will go.

Turn on the visual reference lights in the RamAir System vacuum box.

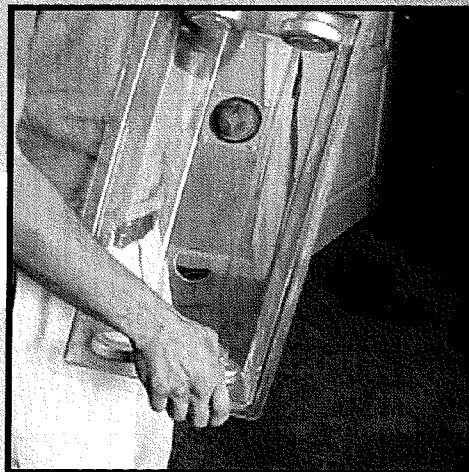

Feed the quick connect coupler on the cleaning hose through the red grommet from the inside of the box and attach it to the on/off valve.

Position the valve close enough to the vacuum box so that you can control it yourself, or have an assistant standing by to operate the valve for you.

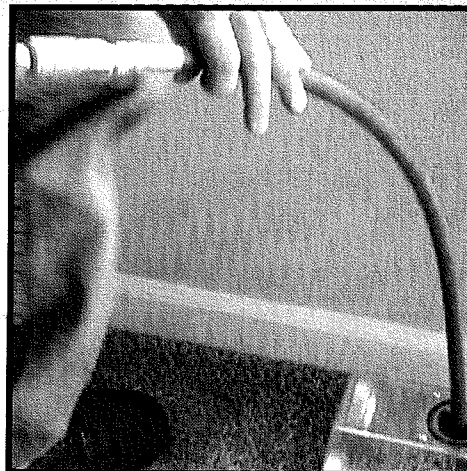

RAM
Air

ClearView Duct Cleaning System

Cleaning the supply ducts.



Take the 1 ½ inch vacuum hose and insert it into the opening on the vacuum box.

While keeping the vacuum box tightly pressed over the register opening, fully open the air valve and begin slowly retracting the cleaning hose out of the duct.

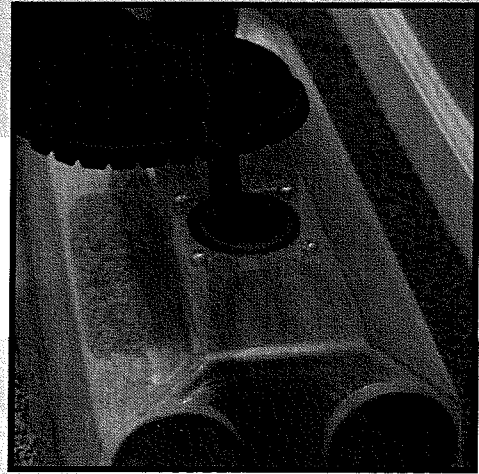

You'll know that you're cleaning effectively when you see dust and debris swirling inside the vacuum box as you withdraw the cleaning hose.

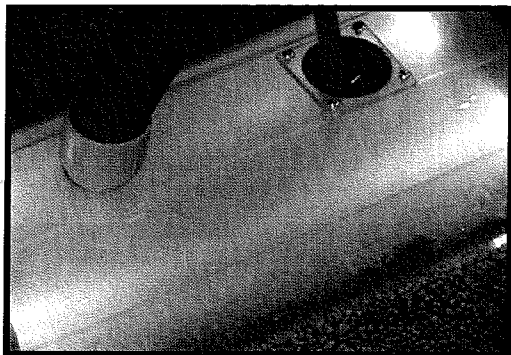

Note: You may wish to invite the homeowner over to watch during this phase of the cleaning. They will be amazed at the amount of debris coming out of their ducts!

Cleaning the supply ducts.

When the duct ball comes into view, turn off the air valve, disconnect the hose from the quick connect coupler and pull the ball through the red grommet while holding the vacuum box on the floor with your foot.

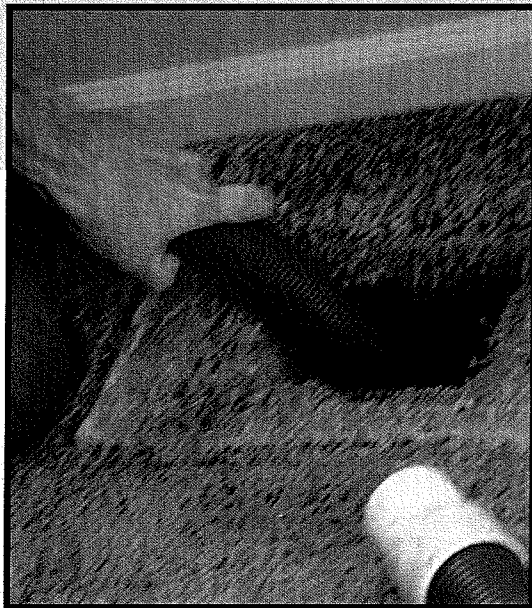
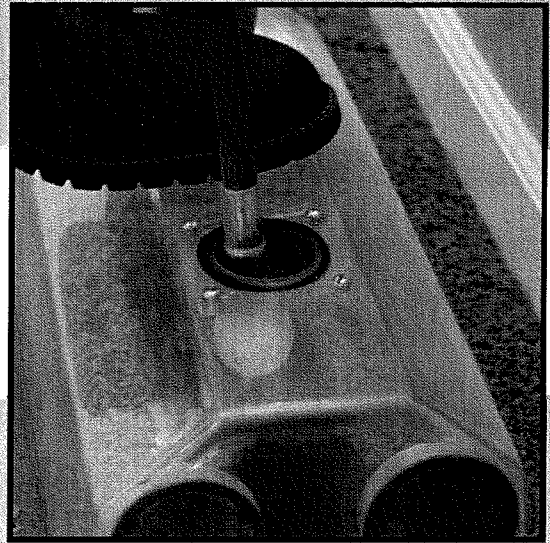

Remove the 1 ½ inch hose from the vacuum box, disconnect it from the 2 inch vacuum hose to temporarily stop vacuum flow, and feed it into the duct while twisting and turning to get around any corners and into the duct as far as possible.

Reattach the 1 ½ inch hose to the 2 inch vacuum hose and begin slowly retracting it from the duct. Twist and turn the hose as you retract it to further loosen and remove any debris remaining inside the duct.

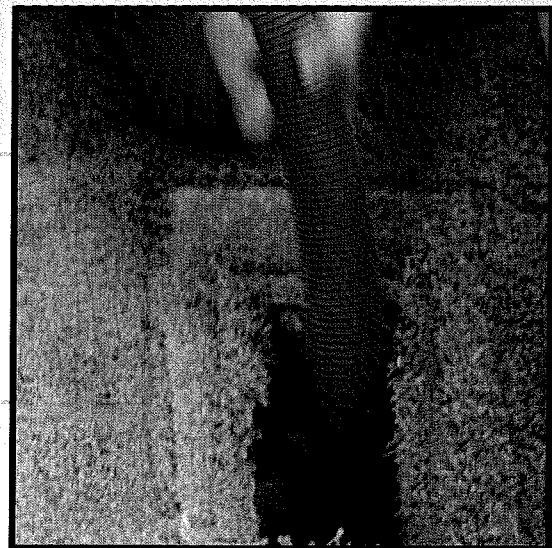

Cleaning the supply ducts.

Once the 1 ½ inch vacuum hose is out, use it to vacuum around the register opening as well as clean the register cover.

Replace the register cover and move to the next register and repeat the process.

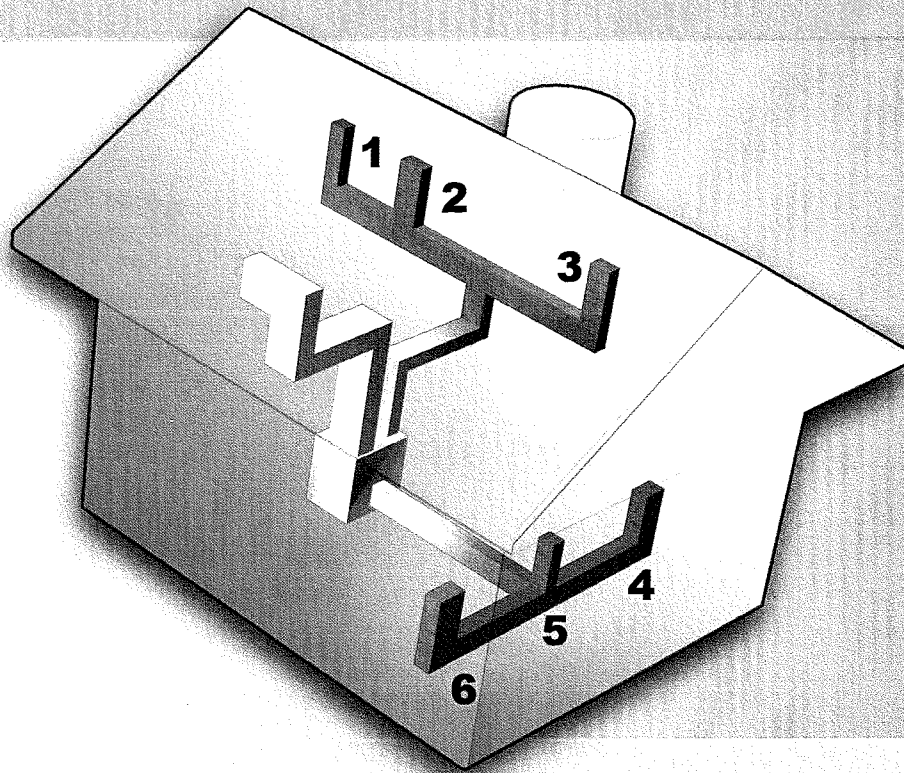

Work in an organized, consistent direction from upper to lower floors until all ducts and registers have been cleaned. This will ensure you haven't missed any ducts.

Finishing up.

Return to the furnace and remove the tape from the fan shut off switch. Replace the furnace inspection cover.

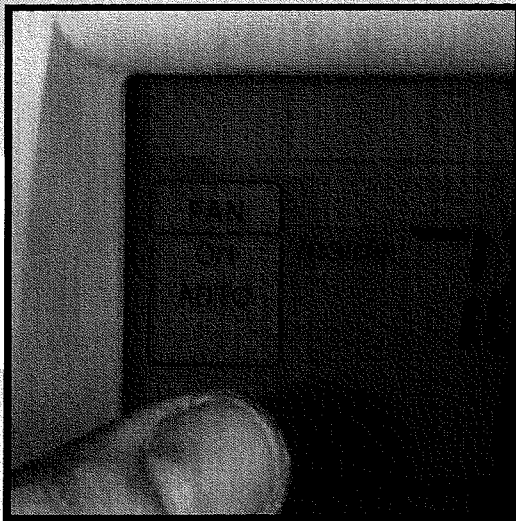
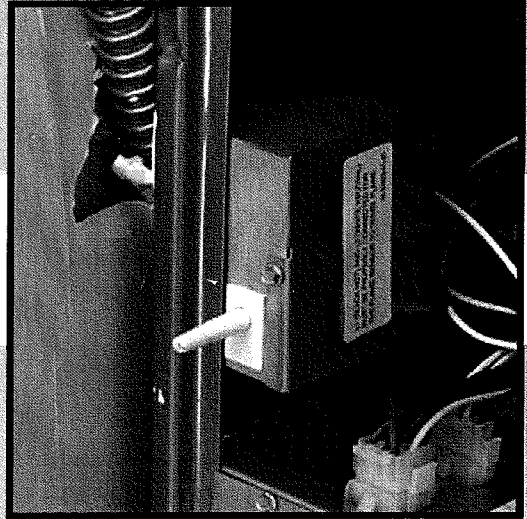

Do a final inspection to ensure all register covers are back in place and no equipment has been left behind. Return to the thermostat and set it back to normal operation.

Dryer Duct Cleaning

Turn the dryer on and locate the dryer vent outside of the building.

Insert the duct ball and hose into the dryer vent being careful not to damage the opening.

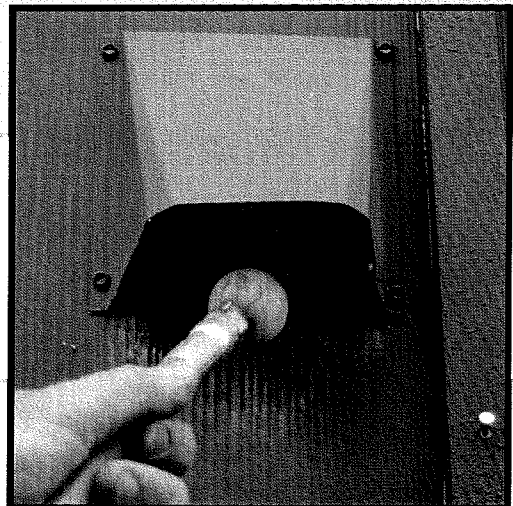

Dryer Duct Cleaning

You may need to lift the flap that covers the vent, or remove any screens or louvers to make room.

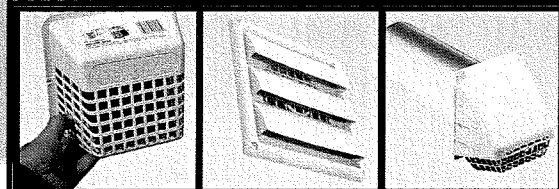

Remove

Gently
Remove Flaps

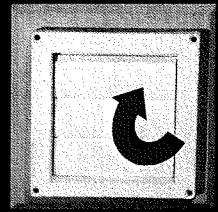

Open the valve and begin slowly retracting the hose toward the opening.

Repeat the process until no more lint is blown out.

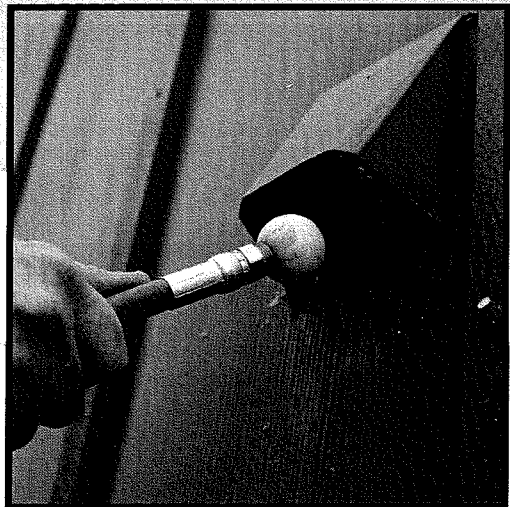

Mobile Home Duct Cleaning

Mobile homes have a unique duct configuration that requires a different approach to cleaning. First verify that the thermostat is set to "FAN OFF."

The duct system in a double wide, for example, is laid out in the shape of an "H." The registers are lined up along the legs.

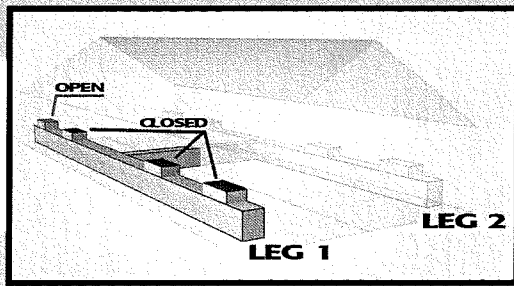
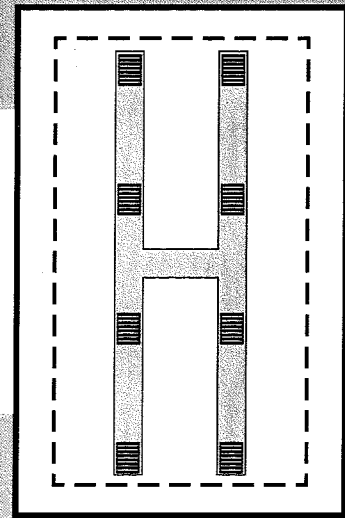

Close all of the registers on one leg except for one on the end, where you will access the duct.

Run the cleaning hose all the way to the end of the leg. Next set up the vacuum box and the vacuum hose. (60' specialized duct hoses are available.)

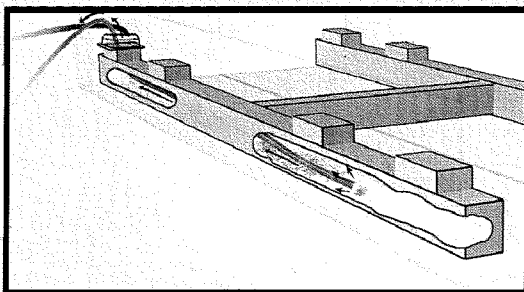
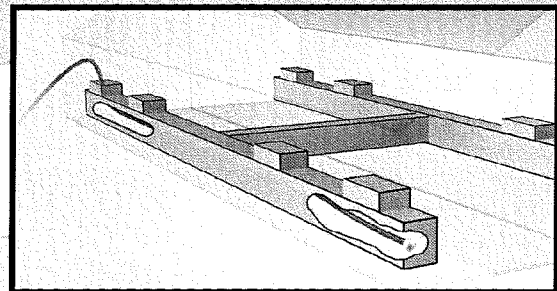

Open valve and blast debris while retracting the hose; then repeat the process on the other leg(s).

Finish by blowing out the air handler in the same manner as a frame built home.

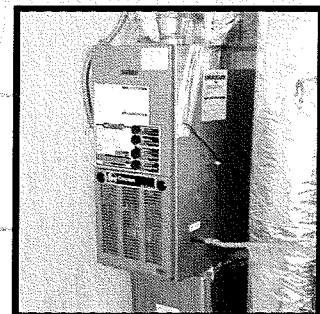

RAM
Air

ClearView Duct Cleaning System

If you need further assistance:

Toll Free: 888-2 RAM AIR (888-272-6247)

email: david@guaranteecleaning.com

Notes:



ClearView Duct Cleaning System